

Content

1. Safety Instruction	2
2. Read before first use	3
3. Function Introduction	5
3.1 Power on Coffee Machine	5
3.2 Main Function Interface	6
3.3 Espresso/Coffee/Cappuccino/Latte/Hot Milk/Hot Water	6
3.4 Coffee Powder Brew Function.....	7
3.5 Coffee powder fineness adjustment knob	8
3.6 Coffee powder volume adjustment.....	8
3.7 Adjusting knob for milk foam regulation.....	9
4. Set Up Menu	10
4.1 Coffee Temperature	10
4.2 Descale	10
4.3 Coffee Volume	11
4.4 Coffee Temperature	11
4.5 Coffee Temperature	11
4.6 Eco Time	14
4.7 Language Selection	15
4.8 Factory Reset	15
4.9 Cup Number Counter	15
5. Warning Icons	16
6. Cleaning and maintenance	18
6.1 Notes about rinsing the milk frother.....	18
6.2 Brewing unit maintenance	19
6.3 Daily Maintenance	20
6.4 Milk frother system maintenance.....	20

This is a watermark for the trial version, register to get the full one!

Benefits for registered users:

- 1.No watermark on the output documents.
- 2.Can operate scanned PDF files via OCR.
- 3.No page quantity limitations for converted PDF files.

Remove Watermark Now

1. Safety Instruction

- (1) Read and preserve the instruction manual carefully.
- (2) Keep the machine on a stable desktop, which is dry, ventilated and out of the reach of children.
- (3) Understand the power specification before using the machine, and connect the power according to the requirement.
- (4) Don't use the machine when it is under water shortage.



When filling the water tank, please remove it from the coffee machine, so that water cannot get into the coffee machine in any way.

Water that enters the interior of the coffee machine can lead to damages that are not covered by the warranty

- (5) Dispose the plastic and bubble board in the package appropriately to avoid hurting children.
- (6) Please keep the machine far from heat producer, avoid the damaging to the surface of machine.

(7) Normal environment temperature for use and storage is 0°C~+45°C, frozen may

This is a watermark for the trial version, register to get the full one!

(8) Please add home temperature water in water container, hot water will damage the

Benefits for registered users:

- 1.No watermark on the output documents.
- 2.Can operate scanned PDF files via OCR.
- 3.No page quantity limitations for converted PDF files.

Remove Watermark Now

(11) Take out the brewing unit and wash each unit only when the machine is powered off.

(12) Please send the machine for professional repairing when it has problem, or the electrical is damaged.

(13) The machine is not applicable to the group deficiency in physical, feelings and mental, including children, except they are under the direction of guardian to operate the machine safely.

(14) Please take care to avoid the entrance of water inside the machine and touch to the electrical parts, it will cause short circuit.

(15) If you will not use the machine for a long period, please power off and disconnect the plug.

(16) Should you have any questions on the machine, Please kindly contact us by service hotline.

2. Read before first use

- (1) Please check and make sure the brewing unit is locked, dump container and drip tray in right position.
- (2) Fill the water tank with clean water.
- (3) Add more than 30g coffee beans into the bean container for first use.



Remarks:

Only coffee beans can be placed in the bean container, please don't add water, coffee power, coffee beans mixed with stones and other hard objects, otherwise the grinder will be damaged.

Voltage / Frequency	220-240VAC 50/60Hz	Rating Power	1200-1500 W
Water Tank Capacity	1800 ml	Bean Capacity	250 grams
Pump Pressure	19 Bar (Italy ULKA pump)	Net weight	13 Kgs

This is a watermark for the trial version, register to get the full one!

Benefits for registered users:

- 1.No watermark on the output documents.
- 2.Can operate scanned PDF files via OCR.
- 3.No page quantity limitations for converted PDF files.

Remove Watermark Now

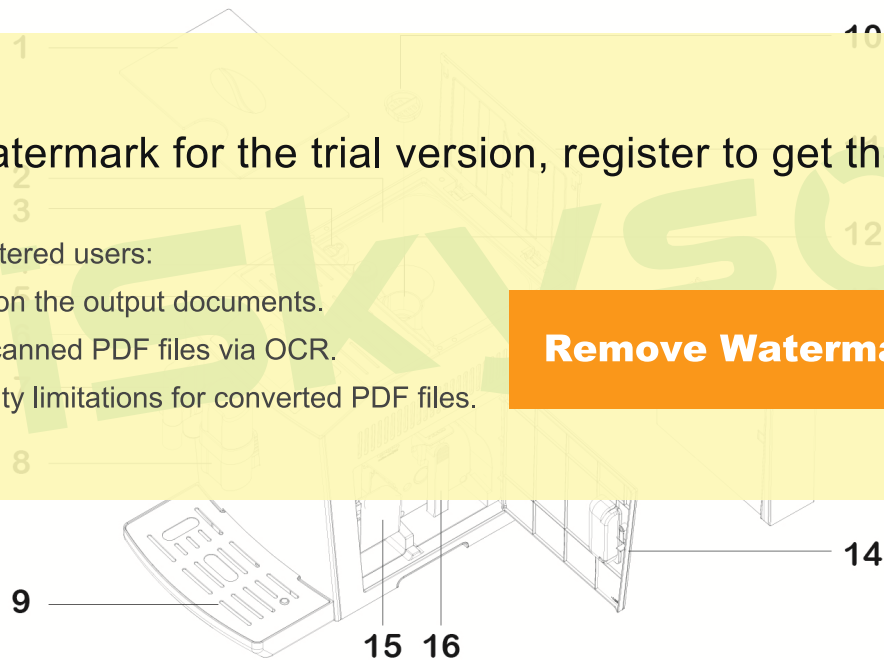

- | | |
|---|---------------------------------------|
| ① Inner lid of coffee bean container | ⑨ Waste water container with cup base |
| ② Coffee Bean Container | ⑩ Lid for coffee powder tunnel |
| ③ Adjusting knob for milk foam regulation | ⑪ Outer lid of coffee bean container |
| ④ Powder fineness adjustment knob | ⑫ Coffee powder tunnel |
| ⑤ Cup warmer | ⑬ Water Container with lid |
| ⑥ LCD colorful touch screen | ⑭ Side door |
| ⑦ Cappuccino/Latte system | ⑮ Waste coffee cake container |
| ⑧ Espresso Outlet | ⑯ Brewing unit |



Remarks(Important):

③ Adjusting knob for milk foam regulation

1. Adjust the knob as clockwise, the milk foam bubble will be more dense and fine;
But if over clockwise adjusted, milk system will produce hot milk only without foam,
and please fine turning the knob back as anti-clockwise to make normal milk foam;

2. Adjust the knob as anti-clockwise, the milk foam bubble will be bigger and coarse;
But if over anti-clockwise adjusted, milk system can not pull up the milk, and please fine
turning the knob back as clockwise to pull up milk to make normal milk foam;

④ Powder fineness adjustment knob:

Please adjust the powder fineness when the grinder is working.

If anti-clockwise adjusted, the powder size will be fine and coffee taste stronger;

If clockwise adjusted, the powder size will be coarse and coffee taste weak.

⑦ Cappuccino/Latte system

This is a watermark for the trial version, register to get the full one!

Benefits for registered users:

- 1.No watermark on the output documents.
- 2.Can operate scanned PDF files via OCR.
- 3.No page quantity limitations for converted PDF files.

Remove Watermark Now

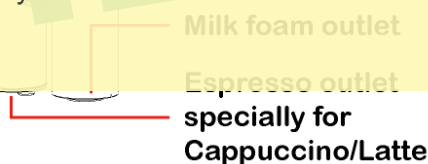

⑨ Waste water container with cup base

When the waste water level is high, and the red floater be raised, please empty the waste water container in time.

⑫ Coffee powder tunnel

Please add no more than 1 spoon coffee powder for each cup coffee, if the powder volume more than 1 spoon, it might cause problem to the brewing unit.

⑮ Waste coffee cake container:

When screen shows "Waste container full", please empty the container in time.

⑯ Brewing unit:

Please don't open the door or move the brewing unit while you are making coffee, if the touch screen shows "brewing unit missing", please take out the brewing unit and push it inside again, until you hear the sound "Ka".

3. Function Introduction

3.1 Power on Coffee Machine

(1) Please connect the power cord to the socket, the touch screen will be lighted with logo and enter stand by mode automatically.

(2) Touch the screen with your finger, the machine will be waken up, start self-test, heating and self-clean process, then enter the main function interface.

Please don't operate the machine during above processes.

Stand by:



This is a watermark for the trial version, register to get the full one!

Benefits for registered users:

- 1.No watermark on the output documents.
- 2.Can operate scanned PDF files via OCR.
- 3.No page quantity limitations for converted PDF files.

Remove Watermark Now

Heating:

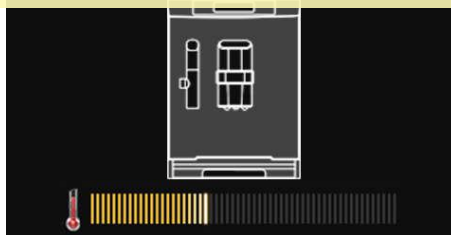

Self-cleaning:



3.2 Main Function Interface



3.3 Espresso/Coffee/Cappuccino/Latte/Hot Milk/Hot Water

Into the main function interface, you can make Espresso, Coffee, Cappuccino, Latte, Hot Milk, Hot Water by One Touch of the icon on the touch screen.

During the espresso/coffee process, users can also press the icon  to stop the process any time.

During the milk frother process, you can also press icon  to stop the milk frother any time.

This is a watermark for the trial version, register to get the full one!

Remarks:

Benefits for registered users:

- 1.No watermark on the output documents.
- 2.Can operate scanned PDF files via OCR.
- 3.No page quantity limitations for converted PDF files.

Remove Watermark Now

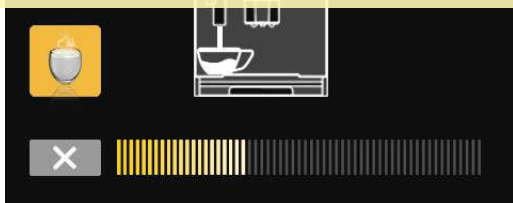

Milk Frother Process

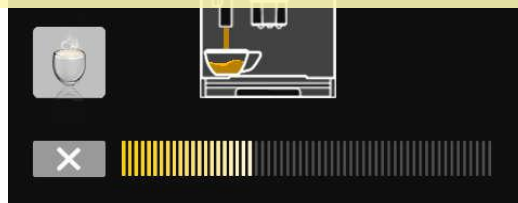

Espresso Process



Coffee Ready

3.4 Coffee Powder Brew Function



(1) Press icon , the display will show 4 function selections for Espresso, Coffee, Cappuccino and Latte.



(2) Please use the coffee powder spoon accessory with coffee machine and add only one spoon of coffee powder for every cup coffee.

This is a watermark for the trial version, register to get the full one!

Benefits for registered users:

- 1.No watermark on the output documents.
- 2.Can operate scanned PDF files via OCR.
- 3.No page quantity limitations for converted PDF files.

[Remove Watermark Now](#)

(3) Press your required coffee function icon, coffee machine will make Espresso / Coffee / Cappuccino / Latte.

If coffee powder is not put in the machine during the above process, the coffee machine only delivers hot water from the coffee spout, it is a cleaning process for the brewing unit and inner coffee tubes.

Additionally, the coffee machine has a self-clean process automatically when you turn on the machine.

3.5 Coffee powder fineness adjustment knob

Please adjust the powder fineness when the grinder is working.

If anti-clockwise adjusted, the powder size will be fine and coffee taste stronger;

If clockwise adjusted, the powder size will be coarse and coffee taste weak.



Remarks:

After adjusting the powder fineness, adjusted coffee effect will exist from the third cup of coffee.

3.6 Coffee powder volume adjustment

Please enter the "Favorite" setting, the coffee bean quantity stands for coffee powder volume from 7-12 grams/cup: press symbol "-" to reduce coffee powder volume

to the least quantity, and press symbol "+" to increase coffee powder volume to the more quantity, as following pictures show.

This is a watermark for the trial version, register to get the full one!

Benefits for registered users:

- 1.No watermark on the output documents.
- 2.Can operate scanned PDF files via OCR.
- 3.No page quantity limitations for converted PDF files.



Remove Watermark Now

OK

OK

3.7 Adjusting knob for milk foam regulation

1. Adjust the knob as clockwise, the milk foam bubble will be more dense and fine;
2. Adjust the knob as anti-clockwise, the milk foam bubble will be bigger and more coarse ;

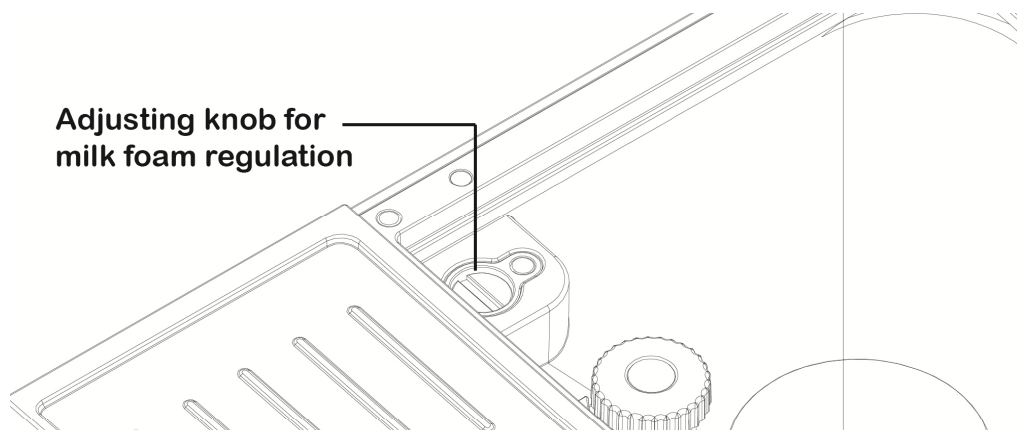

This is a watermark for the trial version, register to get the full one!

Benefits for registered users:

- 1.No watermark on the output documents.
- 2.Can operate scanned PDF files via OCR.
- 3.No page quantity limitations for converted PDF files.

Remove Watermark Now

- (2) If over anti-clockwise adjusted, milk system can not pull up the milk, if so, please fine turning the knob back as clockwise to pull up milk to make normal milk foam;

4. Set Up Menu



Please press icon  in main functional interface and enter Set Up Menu.

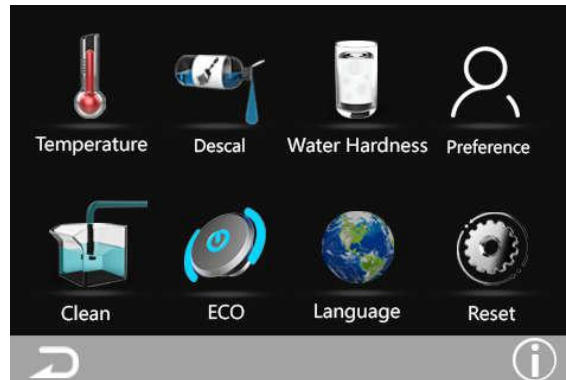

4.1 Coffee Temperature



Press icon  the display will show temperature selection: Low, Middle, High.

Please choose your required temperature, and press "OK" to confirm your selection.

This is a watermark for the trial version, register to get the full one!

Benefits for registered users:

- 1.No watermark on the output documents.
- 2.Can operate scanned PDF files via OCR.
- 3.No page quantity limitations for converted PDF files.

[Remove Watermark Now](#)

4.2 Descal



Press  icon to start descale process, or press  to cancel the descale process anytime needed.

Step 1. Please add detergent into water container and fill the container full with water, press "OK" to start the descaling process. The pump will work for 30 seconds and stop for 3 minutes, and works for 11 rounds, until the descaling process finish.



Step 2. Please change the detergent in water container to clean water, and press "OK", coffee machine will start to clean the inner tube. The clean process will be finished and back to the main function interface after pump 1000ml water.

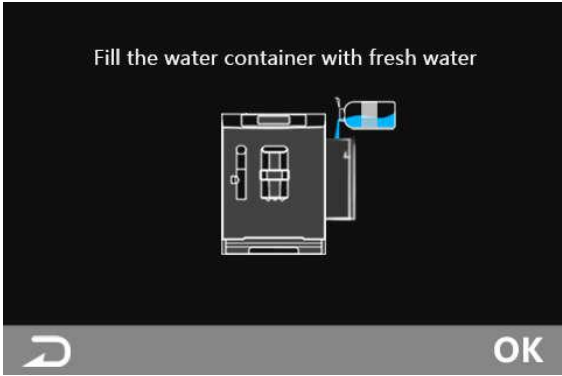

4.3 Water Hardness



Press icon , the display shows water hardness for selection:

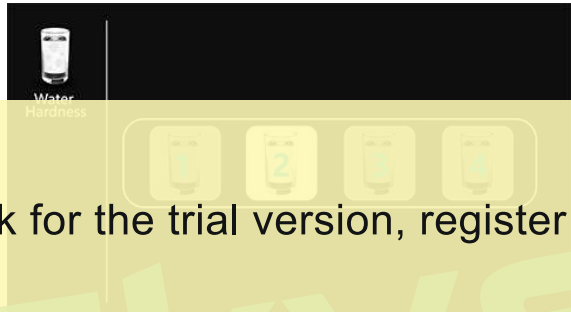

This is a watermark for the trial version, register to get the full one!

Benefits for registered users:

- 1.No watermark on the output documents.
- 2.Can operate scanned PDF files via OCR.
- 3.No page quantity limitations for converted PDF files.

Remove Watermark Now

- (1) Level 1: Remind you to descale after using 150L water;
- (2) Level 2: Remind you to descale after using 120L water;
- (3) Level 3: Remind you to descale after using 90L water;
- (4) Level 4: Remind you to descale after using 60L water

Remarks:





Users can also press  to cancel the descale process upon receiving descale reminding, and the machine will remind the descaling again when users power on the machine next time, until users finish a complete descaling process.

4.4 "Preference" adjustment in "Set Up" before coffee making

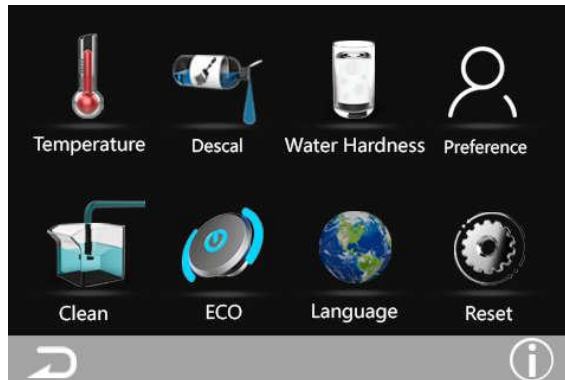

Please press set up icon , following adjustment function interface will be shown on the touch screen.



Please press "Preference" icon , the screen show personal favorite taste adjustment function as following.

This is a watermark for the trial version, register to get the full one!

Benefits for registered users:

- 1.No watermark on the output documents.
- 2.Can operate scanned PDF files via OCR.
- 3.No page quantity limitations for converted PDF files.

Remove Watermark Now



A. Press icon , the display shows espresso volume adjustment function, please press "+" or "-" icon to set required espresso volume, and press "OK" icon to confirm.

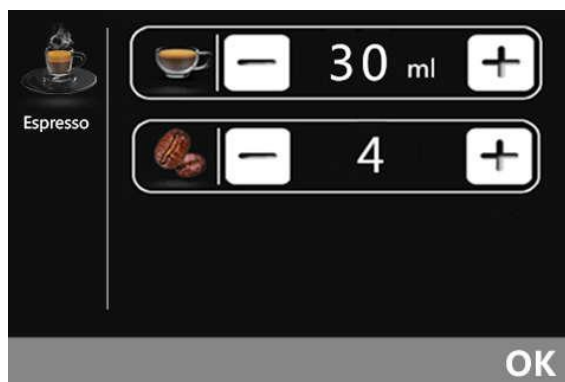

B. Press icon , the display shows coffee volume adjustment function, please press "+" or "-" icon to set required coffee volume, and press "OK" icon to confirm.

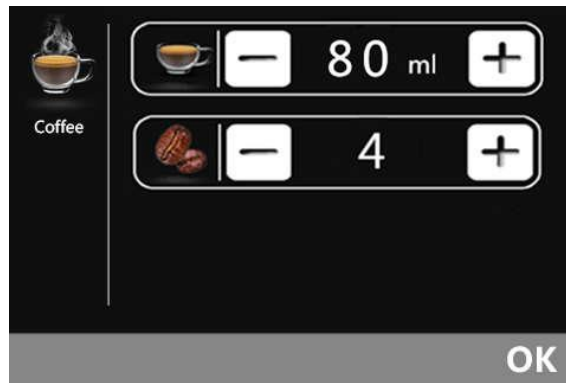

C. Press icon , the display shows cappuccino taste adjustment function, please press “+” or “-” button to adjust the espresso volume and milk frother time, and press “OK” icon to confirm.

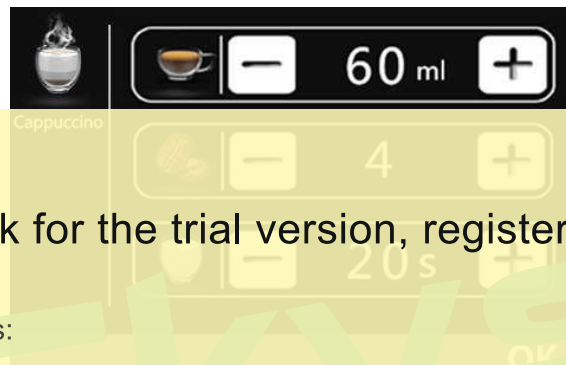

This is a watermark for the trial version, register to get the full one!

Benefits for registered users:

- 1.No watermark on the output documents.
- 2.Can operate scanned PDF files via OCR.
- 3.No page quantity limitations for converted PDF files.

[Remove Watermark Now](#)

“+” or “-” button to set required espresso volume, frother ratio against milk, milk frother time, then press “OK” to confirm.

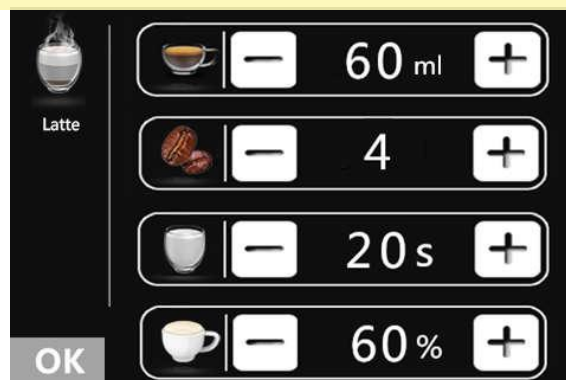

E. Press icon , and press “+” or “-” button to select favorite hot water volume, then press “OK” to confirm.

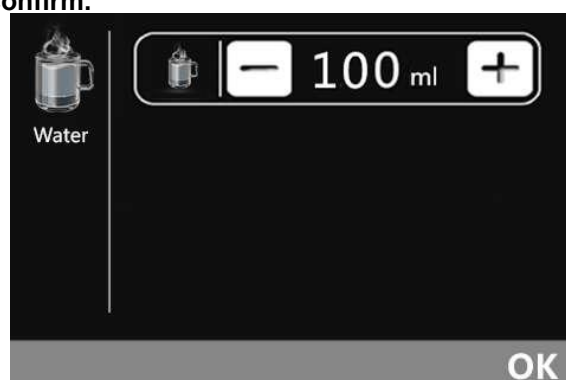

F. Press icon , and press “+” or “-” button to select favorite hot water volume, then press “OK” to confirm.



4.5 Coffee Tube and Milk Foam System Cleaning

Press icon , the display will remind to put the milk tube into clean water, please press “OK”, the machine will clean the milk frother system for 20 seconds, then clean the inner coffee tube for 80ml water.

This is a watermark for the trial version, register to get the full one!

Benefits for registered users:

- 1.No watermark on the output documents.
- 2.Can operate scanned PDF files via OCR.
- 3.No page quantity limitations for converted PDF files.

Remove Watermark Now

Press icon , the display will show the auto-off time for your selection, press “OK” to confirm your selection.

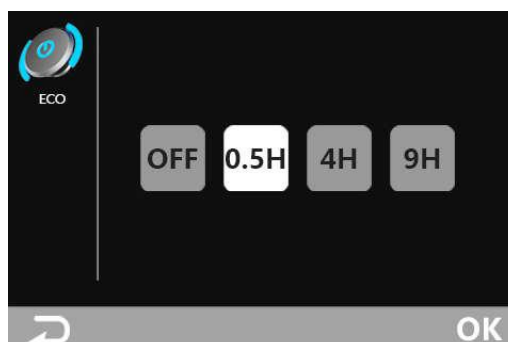

Remarks:

In order to save energy, the Coffee Machine will shut off automatically if users don't operate the machine for a selected time; Users can also select “OFF” to cancel the auto-off function.

4.7 Language Selection

In order to meet the use requirement from different customers and countries, we provide 4 languages for your selection.

Please press icon , the display shows language selection interface, please select the language according to your requirement, and press "OK" to confirm your selection.

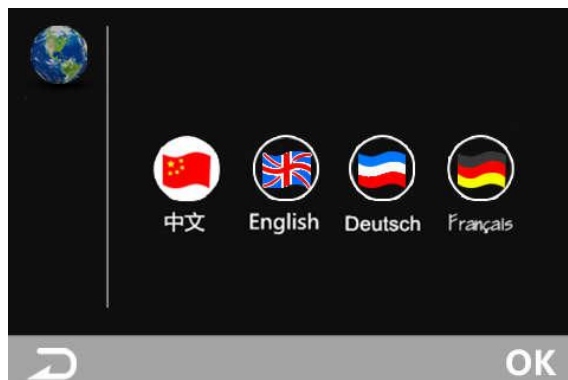

4.8 Factory Reset

Press icon , the display will ask your confirmation for the factory reset, press

This is a watermark for the trial version, register to get the full one!

also press  to cancel the factory reset.

Benefits for registered users:

- 1.No watermark on the output documents.
- 2.Can operate scanned PDF files via OCR.
- 3.No page quantity limitations for converted PDF files.

Remove Watermark Now

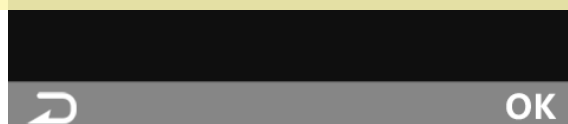

4.9 Cup Number Counter

Press icon , the display shows the total cups of Espresso/Coffee and Cappuccino/Latte made by coffee machine.

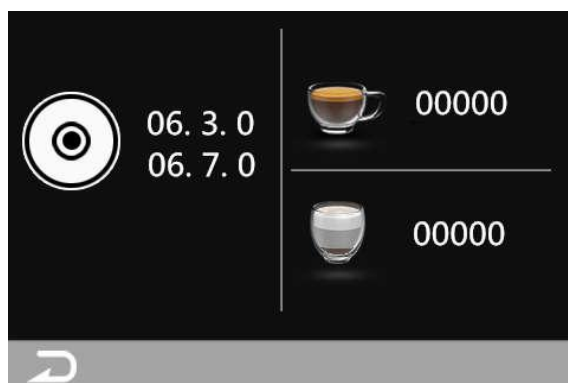

5. Warning Icons

(1) Water Shortage, please add water in water container.



(2) Bean Shortage, please add coffee beans in bean container.



This is a watermark for the trial version, register to get the full one!

Benefits for registered users:

- 1.No watermark on the output documents.
- 2.Can operate scanned PDF files via OCR.
- 3.No page quantity limitations for converted PDF files.

[Remove Watermark Now](#)

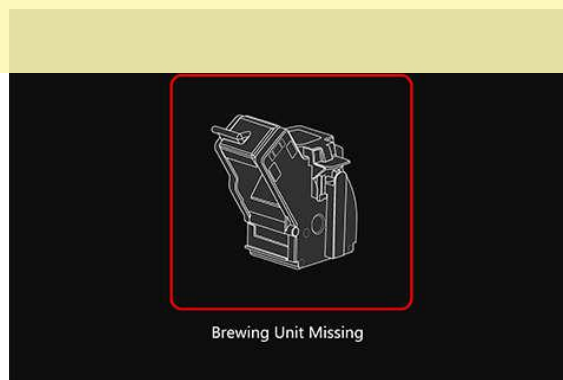

(4) Waste Coffee Cake Container missing, please check if waste container in right position.



(5) Drip Tray missing, please check if Drip Tray in right position.

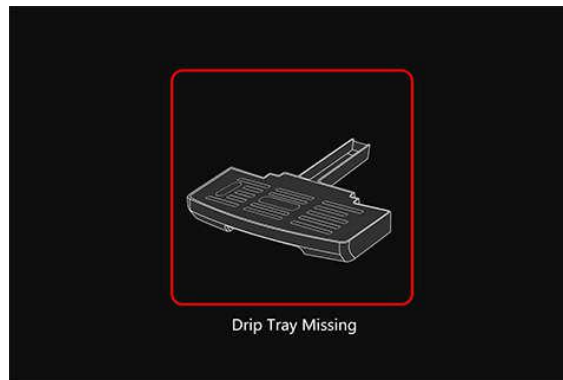

(6) Waste Coffee Cake Container full, please pour off the waste coffee cakes.

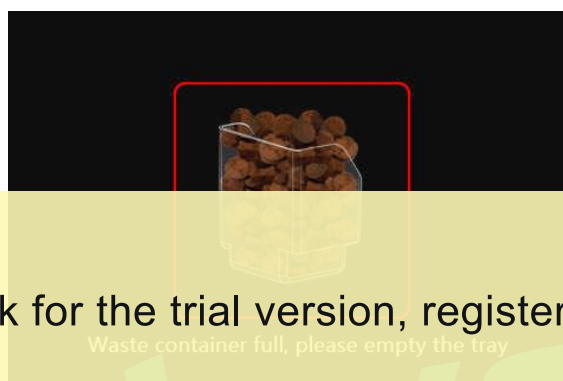

This is a watermark for the trial version, register to get the full one!

Benefits for registered users:

- 1.No watermark on the output documents.
- 2.Can operate scanned PDF files via OCR.
- 3.No page quantity limitations for converted PDF files.

Remove Watermark Now

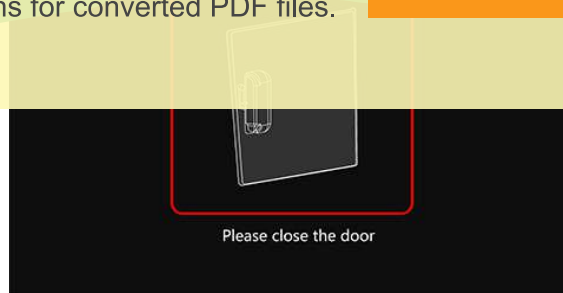

(7) Tube Plugged, please power off the coffee machine, and make sure the water container is full, then power on the machine again. If this problem still exist, please contact service hotline for professional direction.

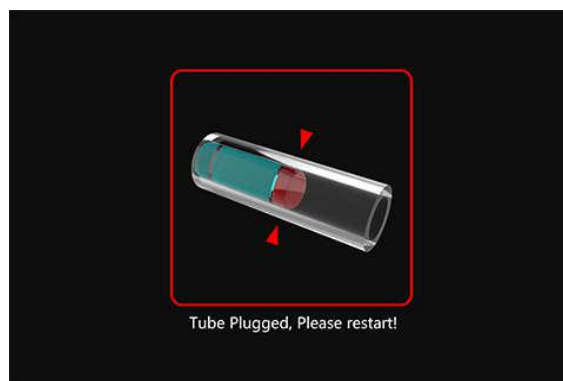

6. Cleaning and maintenance

6.1 Notes about rinsing the milk frother

We suggest the milk frother be rinsed after each use.

The remains of warm milk in the hot frother lead to drying and hardening of milk proteins and can clog up the tubes.

Furthermore, the milk residues can lead to sour, bacterial deposits inside the system after not using the coffee machine for a period of time.

In the setting menu (Img.01) you will find the blue rinse symbol (Img.02) showing the milk tube.

Place the milk tube into a glass of clean water and start the rinsing by pressing the symbol (Img.03).

The milk frother now rinses the tubes with water.



Espresso Coffee Cappuccino Latte

This is a watermark for the trial version, register to get the full one!

Benefits for registered users:

- 1.No watermark on the output documents.
- 2.Can operate scanned PDF files via OCR.
- 3.No page quantity limitations for converted PDF files.

Remove Watermark Now

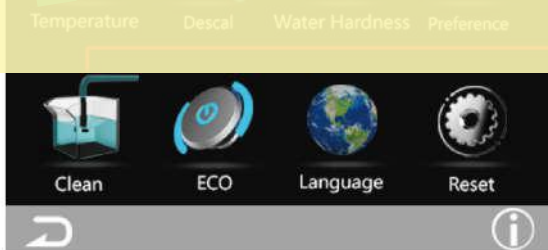

Img. 02
Rinse symbol

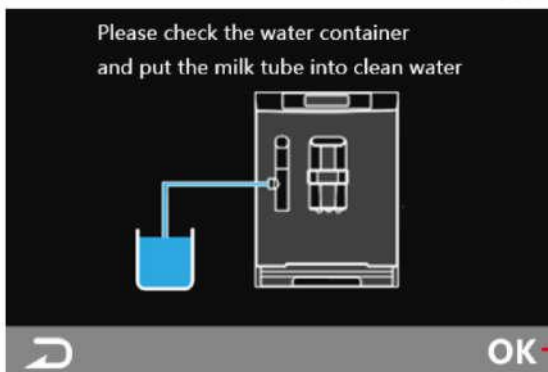

Img. 03
Start

6.2 Brewing unit maintenance

Method to take out the brewing unit



This is a watermark for the trial version, register to get the full one!

1. Open the side door, take out the waste coffee cake container and waste coffee powder container;

Benefits for registered users:

- 1.No watermark on the output documents.
- 2.Can operate scanned PDF files via OCR.
- 3.No page quantity limitations for converted PDF files.

Remove Watermark Now

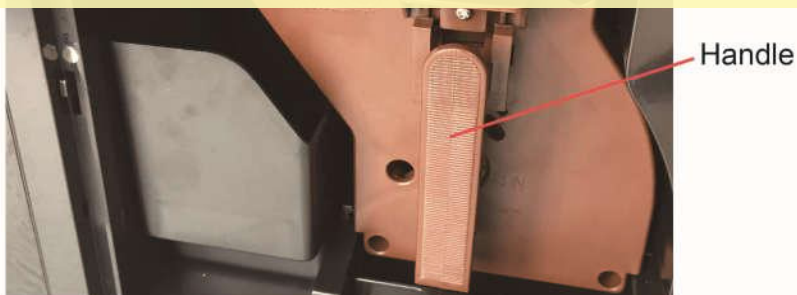

2. Hold the handle of the brewing unit, press down the ear of funnel with your thumb, and then it can be drawn out.

Method to put in the brewing unit:

The onset of the brewing unit takes place in reverse order.

When the sound "kata" is heard, it means put in the brewing unit successfully.

Next, put in the dump container and close the swing door.

6.3 Daily Maintenance

1. Water tank:

It should be on daily cleaning, fill in fresh water before making coffee and better keep the water temperature below 45° and use pure water.

2. Brewing unit:

Wash and clean it when finishing daily household use. In the normal state, just use fresh water to clean it every one week. If it is for restaurant use, then it should be on daily cleaning.

3. Milk frother cleaning:

Clean up the milk remained on the nozzle in time after each frother making and then release hot water.

4. Coffee machine cleaning:

If you would not use the machine for a long time, please clean the dump container, drip tray and each part of the machine to keep it clean.

6.4. Milk Frother system maintenance

This is a watermark for the trial version, register to get the full one!

Benefits for registered users:

- 1.No watermark on the output documents.
- 2.Can operate scanned PDF files via OCR.
- 3.No page quantity limitations for converted PDF files.

After cleaning process, please assemble the milk foam outlet back to the Cappuccino/Latte system.

Remove Watermark Now

